

# XXL

lux collection by Pamesa

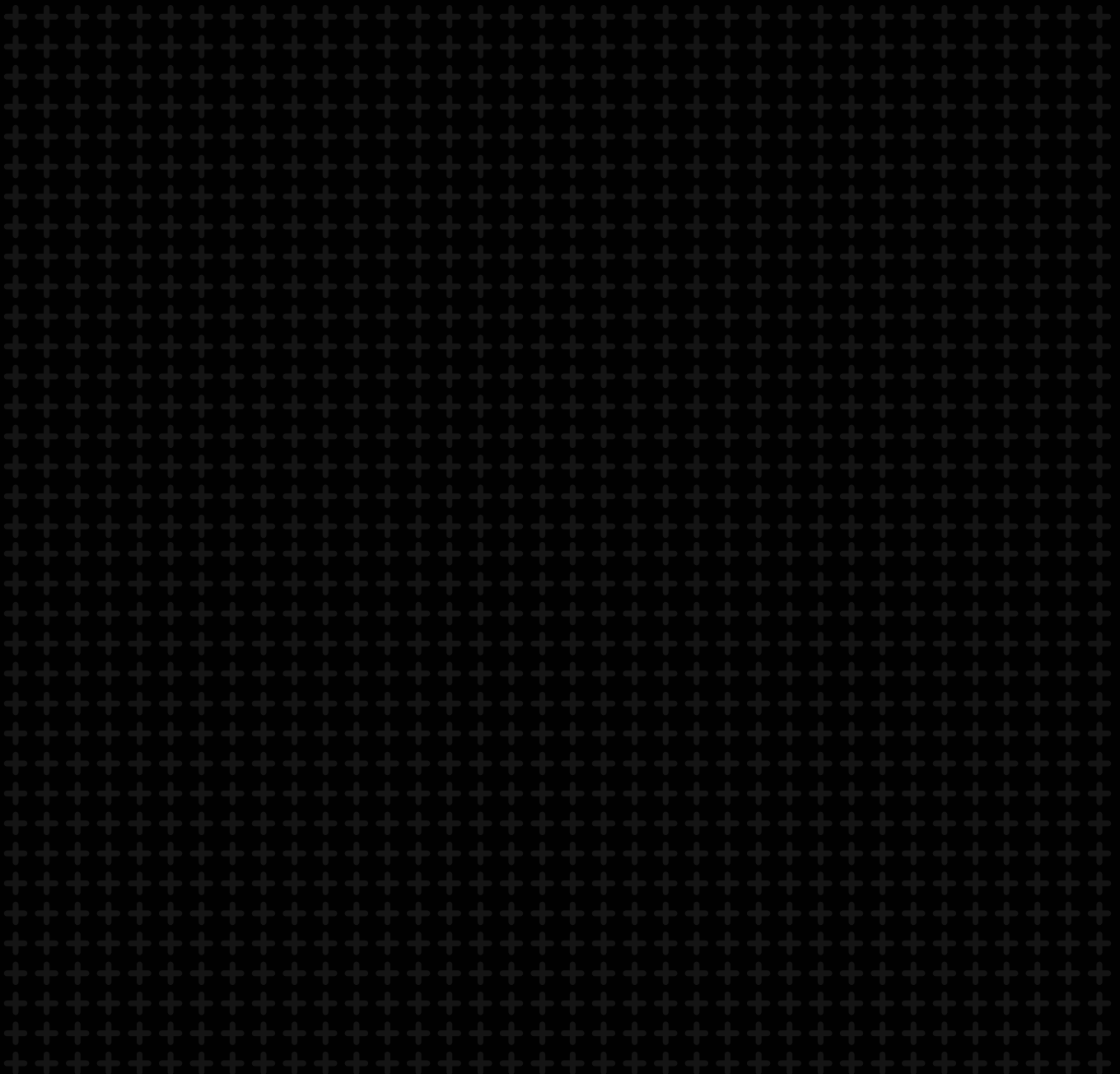

**PAMESA**  
*cerámica*

Edición 2024 / 2024 edition

# Índice

## Index / Index

**04**  
ARMONIA

**06**  
CELLINI

**10**  
CRYSTAL WHITE

**14**  
DESERT

---

**18**  
ELEGANZA

**24**  
ETRO

**28**  
KONCEPT

**32**  
LUX DEVA

---

**36**  
LUX EUPHORIA

**40**  
LUX JATOBÁ

**44**  
LUX LAURANTS

**48**  
LUX PORTORO

---

**52**  
MOLEANOS

**56**  
MONTPELLIER

**60**  
NEBULA

**64**  
PISA

---

**68**  
PLAIN

**70**  
TORANO

**74**  
Get inspired...

**76**  
Expositores y  
recomendaciones  
Display units & recommendations  
Présentoirs et recommandations



## *And the “Dramatic Interior” goes to...*

Alejándonos del minimalismo y prestando especial atención al rol que juega la fuerza geológica, el diseño de interiores consigue crear una tendencia que no deja indiferente a nadie: Dramatic interior. Un movimiento que, influenciado principalmente por el neoclasicismo, se convierte en el impulso para proyectar espacios donde los mármoles y las piedras naturales sean los principales protagonistas. En esta tendencia, las canteras de mármol más prestigiosas del mundo, inspiran y dan lugar a diseños marmóreos con cortes sofisticados y colores exuberantes que, junto a piedras preciosas, convierten a estas piezas en el punto focal de cualquier estancia.

Así mismo, evocando al lujo y a la elegancia, el interiorismo crea espacios donde abunda la teatralidad y el dramatismo, y los avances tecnológicos y los diseños con granilla, logran que la cerámica reconquiste el mundo de la decoración y el interiorismo contemporáneo.

Con sus efectos de veteado, sus matices cromáticos y sus efectos brillantes, nace una colección que define notoriamente la tendencia de la que veníamos hablando.

Grandes diseños con altas prestaciones técnicas que permiten crear impactos visuales y juegos cromáticos en cualquier estancia donde pavimentos o revestimientos tomen el papel principal.

---

Shifting the focus from minimalism to mighty force of geology makes for an interior design trend guaranteed to get heads turning. Dramatic interior is a trend with an essentially neoclassical influence, inspiring spaces with natural marble and stone effects. Stone hewn from the world's most prestigious quarries are the origins of this trend, characterised by marble effect designs featuring sophisticated patterns and bright and beautiful colours which, together with the precious stone effects, will become the focal point of any room.

In an evocation of luxury and elegance, interior design creates dramatically theatrical spaces, applying state-of-the-art technologies and designs with granilla (a granular glaze) to reposition ceramic tiles at the forefront of contemporary interior design and decoration.

Subtle shading, veining and glossy effects are the hallmarks of seven series that together form a collection, the quintessence of the trend defined above.

Superb designs combined with cutting-edge technical features that together allow for stunning visual impacts and clever plays on colour that will look fabulous in any room where wall or floor tiles are a core decorative element.

---

En nous éloignant du minimalisme et en accordant une attention spéciale au rôle que joue la force géologique, le design d'intérieurs parvient à créer une tendance qui ne laisse personne indifférent : Dramatic interior. Un mouvement, principalement influencé par le néoclassicisme, qui insuffle l'élan pour projeter des espaces dans lesquels les marbres et les pierres naturelles ont le premier rôle. Dans cette tendance, les carrières de marbre les plus prestigieuses du monde inspirent et donnent naissance à des designs marbre avec des coupes sophistiquées et des couleurs exubérantes qui, associés à des pierres précieuses, font de ces carreaux le centre d'attention de tous les regards dans n'importe quelle pièce.

De plus, en évoquant le luxe et l'élégance, la décoration d'intérieur crée des espaces où abondent mise en scène et charge dramatique tandis que les avancées technologiques et les designs avec granilla (émail en grain) permettent à la céramique de reconquérir le monde de la décoration et du design d'intérieurs contemporain.

Ses effets de veinure, ses nuances chromatiques et ses effets brillants donnent naissance à huit séries, et qui définit de façon notoire la tendance dont nous venons de parler.

De grands designs avec d'excellentes prestations techniques qui permettent de créer des impacts visuels et des jeux chromatiques dans n'importe quelle pièce en donnant le rôle principal aux carrelages de sol ou de mur.



Formatos / Sizes / Format



# ARMONIA



GRES PORCELÁNICO ESMALTADO RECTIFICADO  
RECTIFIED GLAZED PORCELAIN TILES  
GRÈS CÉRAMÉ ÉMAILLÉ RECTIFIÉE



Rvto. / Wall / Rvrm.: Eleganza Beige 120x280 - Armonia 120x280  
Pvto. / Floor / Sol: Eleganza Beige 60x60

### Empaquetado / Packaging / Emballage

Formato	pz/pl	m <sup>2</sup> /caja	m <sup>2</sup> /pl	kg/pl
120x280	20	3.36	67.20	1,130.00

### Armonia

● 120x280 Rec. P4400 055.964.0001.07413

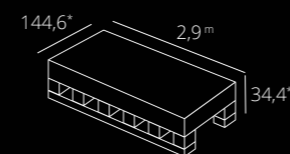

\*Medidas en centímetros  
\*Dimensions in centimeters  
\*Dimensions en centimètres

# CELLINI

## DISEÑO SUAVE Y DIFERENTE

CELLINI, un homenaje al clásico mármol de los Calacatta Statuario, formado habitualmente por vetas expandidas que son consecuencia de una abundante concentración de minerales filossilicatos. Vetas finas y paralelas en diferentes tonos grises, que destacan sobre un fondo de color blanco puro.

Un diseño suave y diferente.

## DISTINCTIVE GENTLE-LOOKING DESIGN

CELLINI is a tribute to classic Calacatta Statuary marble, whose surface is normally shot with thick veins due to its large concentrations of phyllosilicate minerals. Accompanying slender parallel veins in different shades of grey stand out against a dazzling white background, lending it a distinctive gentle-looking design.

## DESIGN DOUX ET DIFFÉRENT

CELLINI, un hommage au marbre classique des Alpes apuanes, habituellement constitué de veines fruits d'une abondante concentration de phyllosilicates. Des veines fines et parallèles dans différents tons gris, qui se détachent sur un fond blanc pur. Un design doux et différent.



Rvto. / Wall / Rvtn.: Cellini Blanco 120x280 Cr.Lux  
Pvto. / Floor / Sol: Wells M. Ash 120x120



blanco

Formatos / Sizes / Format



Disponible / Available / Disponible:  
Cat. MATERIA

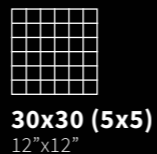
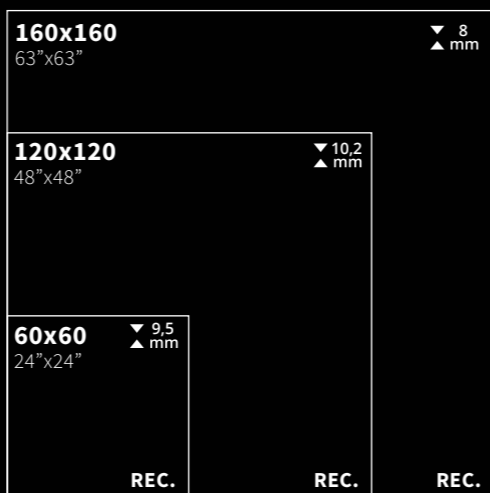

# CELLINI



**CR. LUX**  
GRES PORCELÁNICO RECTIFICADO-GRANILLA PULIDA  
RECTIFIED PORCELAIN TILES-POLISHED GRANILLA  
GRÈS CÉRAMÉ RECTIFIÉE - GRANILLA POLI

**COMPACGLASS**  
GRES PORCELÁNICO ESMALTADO RECTIFICADO  
RECTIFIED GLAZED PORCELAIN TILES  
GRÈS CÉRAMÉ ÉMAILLÉ RECTIFIÉE



Rvto. / Wall / Rvtm.: Cellini Blanco 60x120 Leviglass  
Pvto. / Floor / Sol: Cellini Blanco 120x120 Leviglass

Empaquetado / Packaging / Emballage

Formato	pz/pl	m <sup>2</sup> /caja	m <sup>2</sup> /pl	kg/pl
120x280	20	3.36	67.20	1,130.00

Cellini Blanco

● 120x280	Rec.	M316	054.961.0012.09556	
● 120x280	Rec.	M220	052.961.0012.09556	

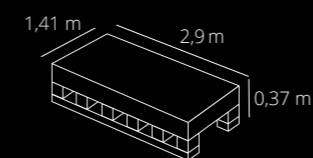

\*Medidas en centímetros  
\*Dimensions in centimeters  
\*Dimensions en centimètres

# CRYSTAL WHITE

## UNA PIEDRA PRECIOSA BRASILEÑA

Este modelo está inspirado en la cuarcita blanca de Brasil. Una piedra con una superficie blanca que se ve atravesada por delicadas vetas en tonos beige y gris. Sus destellos dorados ayudan a resaltar la profundidad de este preciado diseño.

## A PRECIOUS STONE FROM BRAZIL

This model is inspired by white quartz from Brazil. A stone featuring a white surface traced with delicate veining in shades of beige and grey. Sparkling gold glints highlight the depth of this highly appreciated design.

## UNE PIERRE PRÉCIEUSE BRÉSILIENNE

Ce modèle est inspiré du quartzite blanc du Brésil. Une pierre avec une surface blanche traversée par des veines délicates dans les tons beige et gris. Ses éclats dorés aident à rehausser la profondeur de ce précieux design.





Formatos / Sizes / Format



Disponibile / Available / Disponible:  
Cat. UNIVERSE

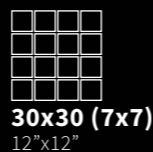
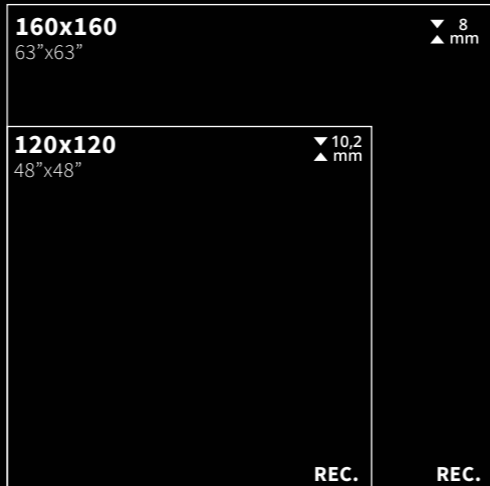
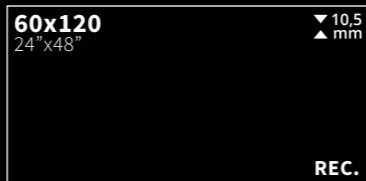

# CRYSTAL WHITE



**CR. LUX**  
GRES PORCELÁNICO RECTIFICADO-GRANILLA PULIDA  
RECTIFIED PORCELAIN TILES-POLISHED GRANILLA  
GRÈS CÉRAMÉ RECTIFIÉE - GRANILLA POLI

**COMPACGLASS**  
GRES PORCELÁNICO ESMALTADO RECTIFICADO  
RECTIFIED GLAZED PORCELAIN TILES  
GRÈS CÉRAMÉ ÉMAILLÉ RECTIFIÉE



Rvto. / Wall / Rvtm.: Crystal White 120x280 Cr.Lux  
Pvto. / Floor / Sol: Crystal White 120x120 Leviglass

## Empaquetado / Packaging / Emballage

Formato	pz/pl	m <sup>2</sup> /caja	m <sup>2</sup> /pl	kg/pl
120x280	20	3.36	67.20	1,130.00

## Crystal White

● 120x280	Rec.	M316	054.961.0001.11484	
● 120x280	Rec.	M220	052.961.0001.11484	

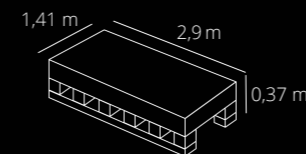

\*Medidas en centímetros  
\*Dimensions in centimeters  
\*Dimensions en centimètres



# DESERT

## PURA ESENCIA JORDANA

Vetas discontinuas, gráciles, oscuras, pero de tonificadas, son las protagonistas en **DESERT**. Un homenaje a la belleza de la piedra de Jordania que, con su fondo blanco cremoso y el vigor de su superficie, invita a crear espacios llenos de sofisticación y elegancia.

## PURE JORDANIAN ESSENCE

Gracefully broken veining in dark yet shaded tones is the defining feature of **DESERT**, which extols the beauty of Jordanian stone, with its creamy white background and bold surface pattern. An invitation to create spaces filled with elegant sophistication that is impossible to resist.

## PURE ESSENCE JORDANIANNE

Les veinures discontinues, gracieuses, sombres mais avec variation de tons sont les protagonistes de la série **DESERT**. Un hommage à la beauté de la pierre de Jordanie qui, avec son fond blanc crème et la vigueur de sa surface, invite à créer des espaces respirant la sophistication et l'élégance.



Rvto. / Wall / Rvtn.: Desert Natural 120x280  
Pvto. / Floor / Sol: Argile Earth 90x90



natural

Formatos / Sizes / Format



Disponible / Available / Disponible:  
Cat. MATERIA

<b>120x120</b> 48"x48"	▼ 10,2 ▲ mm	
<b>90x90</b> 36"x36"	▼ 10,5 ▲ mm	
<b>60x60</b> 24"x24"	▼ 9,5 ▲ mm	
REC.	REC.	REC.

<b>75x150</b> 30"x60"	▼ 10,5 ▲ mm	
<b>60x120</b> 24"x48"	▼ 10,5 ▲ mm	
REC.	REC.	

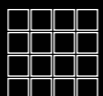
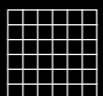
	
<b>30x30 (7x7)</b> 12"x12"	<b>30x30 (5x5)</b> 12"x12"

	<b>32,5x22,5</b> 13"x9"
---	----------------------------

# DESERT



**CR. LUX**  
GRES PORCELÁNICO RECTIFICADO-GRANILLA PULIDA  
RECTIFIED PORCELAIN TILES-POLISHED GRANILLA  
GRÈS CÉRAMÉ RECTIFIÉE - GRANILLA POLI



Rvto. / Wall / Rvrm.: Desert Natural 120x280 - Rovere Brown 25x150  
Pvto. / Floor / Sol: Argile Ivory 120x120

Empaquetado / Packaging / Emballage

Formato	pz/pl	m <sup>2</sup> /caja	m <sup>2</sup> /pl	kg/pl
120x280	20	3.36	67.20	1,130.00

Desert Natural

● 120x280	Rec.	M316	054.961.0102.04037	
-----------	------	------	--------------------	---

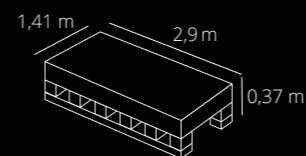

\*Medidas en centímetros  
\*Dimensions in centimeters  
\*Dimensions en centimètres

# ELEGANZA

## LLENA DE FUERZA

ELEGANZA llega como una colección vibrante y llena de fuerza. Articulada en siete tonalidades, con una paleta de elegantes tonos neutros, pero también colores vivos y brillantes.

## POWERFUL COLLECTION

ELEGANZA has now landed as a vibrant, powerful collection. Split into seven colour schemes, using a palette of elegant neutral tones as well as bright vibrant colours.

## PLEINE DE FORCE

ELEGANZA vient comme une collection vibrante et pleine de force. Elle se décline en sept teintes, avec une palette d'élégantes nuances neutres, mais aussi des couleurs vives et lumineuses.



Rvto. / Wall / Rvrm.: Eleganza Beige 120x280  
Pvto. / Floor / Sol: Calacata Gold 120x120 Leviglass

6 mm



Disponibile / Available / Disponible:  
Cat. UNIVERSE

<b>60x120</b> 24"x48"	▼ 10,5 ▲ mm	
<b>30x60</b> 8"x48"	▼ 9,5 ▲ mm	REC.

<b>160x160 Perla</b> 63"x63"	▼ 8 ▲ mm	
<b>60x60</b> 24"x24"	▼ 9,5 ▲ mm	REC.

<b>REC.</b>	<b>9x60</b> 4"x24"	▼ 9,5 ▲ mm
-------------	-----------------------	---------------

Disponibile / Available / Disponible:  
Eleganza 33,3x100 - 30x60  
Rev. Pasta Blanca /  
White body wall tiles / Revêtement pâte blanche

Disponibile / Available / Disponible:  
Cat. ORIGIN

<b>7,5x30</b> 3"x12"	▼ 10 ▲ mm	
-------------------------	--------------	--

# ELEGANZA



**DECORSTONE**  
GRES PORCELÁNICO RECTIFICADO  
RECTIFIED PORCELAIN TILES  
GRÉS CÉRAMÉ RECTIFIÉE



Rvto. / Wall / Rvtrm.: Eleganza Grigio 120x280 - Eleganza Perla 120x280  
Pvto. / Floor / Sol: Eleganza Grigio 60x60

## Empaquetado / Packaging / Emballage

Formato	pz/pl	m <sup>2</sup> /caja	m <sup>2</sup> /pl	kg/pl
120x280	20	3.36	67.20	1,130.00

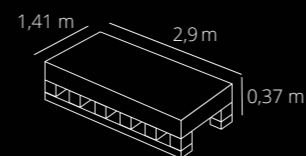

\*Medidas en centímetros  
\*Dimensions in centimeters  
\*Dimensions en centimètres

## Eleganza Beige

● 120x280	Rec.	M220	052.961.0007.11183	
-----------	------	------	--------------------	--

## Eleganza Perla

● 120x280	Rec.	M220	052.961.0037.11183	
-----------	------	------	--------------------	--

## Eleganza Grigio

● 120x280	Rec.	M220	052.961.0213.11183	
-----------	------	------	--------------------	--

# ELEGANZA



Formatos / Sizes / Format



Disponibile / Available / Disponible:  
Cat. UNIVERSE



Disponibile / Available / Disponible:  
Eleganza 33,3x100 - 30x60  
Rev. Pasta Blanca /  
White body wall tiles / Revêtement pâte blanche

Disponibile / Available / Disponible:  
Cat. ORIGIN

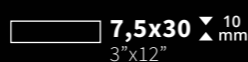

Rvto. / Wall / Rvtm.: Eleganza Siena 120x280  
Pvto. / Floor / Sol: Calacata Gold 120x120 Leviglass

Empaquetado / Packaging / Emballage

Formato	pz/pl	m <sup>2</sup> /caja	m <sup>2</sup> /pl	kg/pl
120x280	20	3.36	67.20	1,130.00

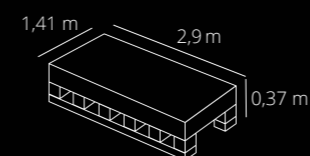

\*Medidas en centímetros  
\*Dimensions in centimeters  
\*Dimensions en centimètres

**Eleganza Blu**

● 120x280 Rec. M220 052.961.0158.11183

**Eleganza Siena**

● 120x280 Rec. M220 052.961.0053.11183

**Eleganza Terra**

● 120x280 Rec. M220 052.961.0056.11183

**Eleganza Saggio**

● 120x280 Rec. M220 052.961.0942.11183

# ETRO

## TONALIDADES CAUTIVADORAS

La poderosa presencia de la Piedra se fusiona con tonalidades cautivadoras para dar vida a la base **ETRO**.

Un testimonio de sofisticación y estilo.

## CAPTIVATING TONES

The powerful presence of Stone merges with captivating tones to give life to the **ETRO** base. A

testament to sophistication and style.

## TONS CAPTIVANTS

La présence puissante de la Pierre se fond avec des tons captivants pour donner vie à la base **ETRO**. Un

témoignage de sophistication et de style.



# ETRO



Formatos / Sizes / Format

**120x280**  
48"x110"

6 mm



Disponibile / Available / Disponible:  
Cat. MATERIA

**60x120** ▼ 10,5 mm  
24"x48"

**30x60** ▼ 9,5 mm  
8"x48"

REC. REC.

**120x120** ▼ 10,2 mm  
48"x48"

**90x90** ▼ 10,5 mm  
36"x36"

**60x60** ▼ 9,5 mm  
24"x24"

REC. REC. REC.

Disponibile / Available / Disponible:  
60x120 EXT. - 60x60 EXT.  
60x90 (20mm) - 60,5x60,5 (20mm)

Disponibile / Available / Disponible:  
Etro 30x90  
Cat. MATERIA  
Rev. Pasta Blanca /  
White body wall tiles / Revêtement pâte blanche



Rvto. / Wall / Rvtm.: Etro Marfil 60x120 - Etro Blanco 60x120  
Pvto. / Floor / Sol: Etro Blanco 120x120

Empaquetado / Packaging / Emballage

Formato	pz/pl	m <sup>2</sup> /caja	m <sup>2</sup> /pl	kg/pl
120x280	20	3.36	67.20	1,130.00

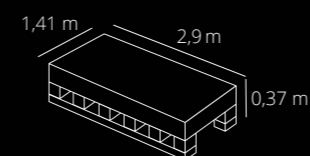

\*Medidas en centímetros  
\*Dimensions in centimeters  
\*Dimensions en centimètres

**ETRO Blanco**

● 120x280 Rec. M220 052.961.0012.14312

**ETRO Marfil**

● 120x280 Rec. M220 052.961.0033.14312

# KONCEPT

## LA ELEGANCIA DEL CEMENTO COMO BASE COMBINATORIA

De inspiración minimalista, **KONCEPT** reproduce el diseño del cemento como base para crear interiores exclusivos en los que la sintonía cromática y las posibilidades combinatorias alcanzan su máxima expresión. Una colección que se completa con cinco series más, configurando una unidad decorativa superior de texturas evocadoras.

## THE ELEGANCE OF CEMENT AS A BASE FOR NUMEROUS COMBINATIONS

Inspired by minimalism, **KONCEPT** takes the design of cement as the foundation for creating exclusive interiors where finely balanced colour and potential combinations know no bounds. This collection is accompanied by five series to offer a superior quality decorative ensemble of evocative textures.

## L'ÉLÉGANCE DU CIMENT COMME BASE POUR LES COMBINAISONS

D'inspiration minimaliste, **KONCEPT** reproduit le design du ciment comme base pour créer des intérieurs exclusifs, où l'harmonie chromatique et les possibilités combinatoires atteignent leur expression maximale. Une collection qui se complète par cinq autres séries, configurant une unité décorative supérieure aux textures évocatrices. Son design ne termine pas avec chaque pièce, car sa singularité réside dans sa coordination chromatique, mélange de formats et combinaison de textures.





Formatos / Sizes / Format



Disponible / Available / Disponible:  
Cat. UNIVERSE

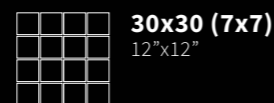
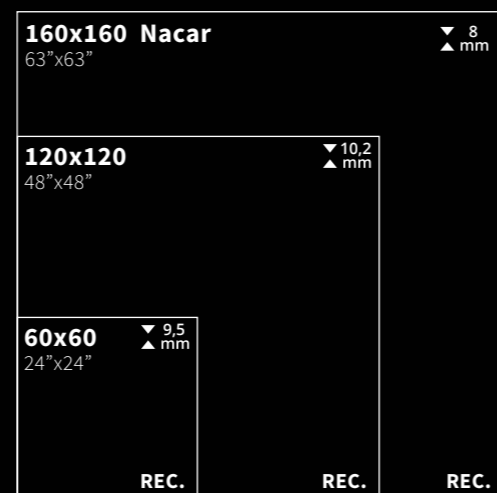

Disponible / Available / Disponible:  
Koncept 40x120  
Cat. UNIVERSE  
Rev. Pasta Blanca / Revêtement pâte blanche

# KONCEPT



**COMPACTTO PEDRA**  
GRES PORCELÁNICO RECTIFICADO  
RECTIFIED PORCELAIN TILES  
GRÈS CÉRAMÉ RECTIFIÉE



Rvto. / Wall / Rvtm.: Koncept Nacar 120x280  
Pvto. / Floor / Sol: Montpellier Graphite 120x120

Empaquetado / Packaging / Emballage

Formato	pz/pl	m <sup>2</sup> /caja	m <sup>2</sup> /pl	kg/pl
120x280	20	3.36	67.20	1,130.00

Koncept Nacar

● 120x280	Rec.	M220	052.961.0030.02967	
-----------	------	------	--------------------	--

Koncept Argent

● 120x280	Rec.	M220	052.961.0135.02967	
-----------	------	------	--------------------	--

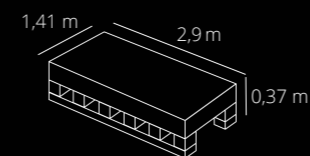

\*Medidas en centímetros  
\*Dimensions in centimeters  
\*Dimensions en centimètres

nacar

argent

# LUX DEVA

## OSCURIDAD DE LA NOCHE

LUX DEVA es la oscuridad de la noche, un fondo negro iluminado por radiantes vetas blancas.

Un mármol noble y elegante que nace en las canteras del País Vasco. Deva, reproduce al negro Marquina y saca a relucir todas las mezclas de calcita blanca y fósiles propios de este diseño tan espectacular.

## DARKNESS OF NIGHT

LUX DEVA conjures up the darkness of night, with a black background lit up by radiant white veins. All the beauty of black Marquina marble, a fine-quality elegant stone quarried in the Basque Country, has been carefully reproduced, highlighting the mixes of white calcite and fossils found in its spectacular design.

## L'OBSCURITÉ DE LA NUIT

LUX DEVA est l'obscurité de la nuit, un fond noir éclairé par de radiantes veines blanches.

Un marbre noble et élégant né dans les carrières du Pays basque. Deva reproduit le noir Marquina et met en avant tous les mélanges de calcite blanche et de fossiles propres à ce design si spectaculaire.





nero

Formatos / Sizes / Format



Disponibile / Available / Disponible:  
Cat. MATERIA

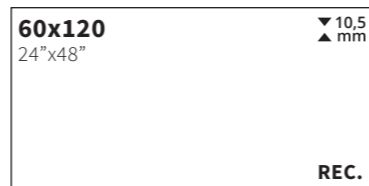
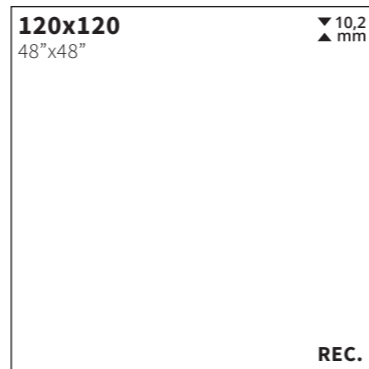

**32,5x22,5**  
13"x9"

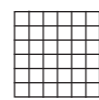

**30x30 (5x5)**  
12"x12"



**13x15**  
5"x6"

# LUX DEVA

**CR. LUX**  
GRES PORCELÁNICO RECTIFICADO-GRANILLA PULIDA  
RECTIFIED PORCELAIN TILES-POLISHED GRANILLA  
GRÈS CÉRAMÉ RECTIFIÉE - GRANILLA POLI



Rvto. / Wall / Rvtm.: Lux Deva Nero 120x280  
Pvto. / Floor / Sol: Cromat Gris 120x120 Rectificado

Empaquetado / Packaging / Emballage

Formato	pz/pl	m <sup>2</sup> /caja	m <sup>2</sup> /pl	kg/pl
120x280	20	3.36	67.20	1,130.00

Lux Deva Nero

● 120x280 Rec. M316 054.961.0215.09564

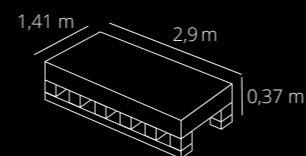

\*Medidas en centímetros  
\*Dimensions in centimeters  
\*Dimensions en centimètres

# LUX EUPHORIA

## ELEGANCIA INNATA

LUX EUPHORIA reproduce la belleza más pura e incomparable de la piedra Verde Borgoña. Un diseño de fondo verde, oscuro y profundo, como si de un bosque se tratara. Un paisaje que se ve iluminado por infinitos destellos blancos y ocres que siguen el trazo de un pincel. Intenso y casi tridimensional. Euphoria aportará a cualquier espacio un toque diferencial y con carácter.

## INNATE ELEGANCE

LUX EUPHORIA reproduces the purest and most incomparable beauty of the Verde Borgoña stone. A design with a deep, dark green background, as if it were a forest. A landscape that is illuminated by infinite white and ochre sparkles that follow the stroke of a paintbrush. Intense and almost three-dimensional. Euphoria will give any space a distinctive touch with character.

## L'ÉLÉGANCE INNÉE

LUX EUPHORIA souligne la beauté la plus pure et la plus incomparable de la pierre verte de Bourgogne. Un dessin avec un fond vert foncé, comme s'il s'agissait d'une forêt. Un paysage illuminé par des éclats blancs et ocres qui suivent le coup de pinceau. Intense et presque tridimensionnel. Euphoria offrira à tout espace une touche différente de caractère.



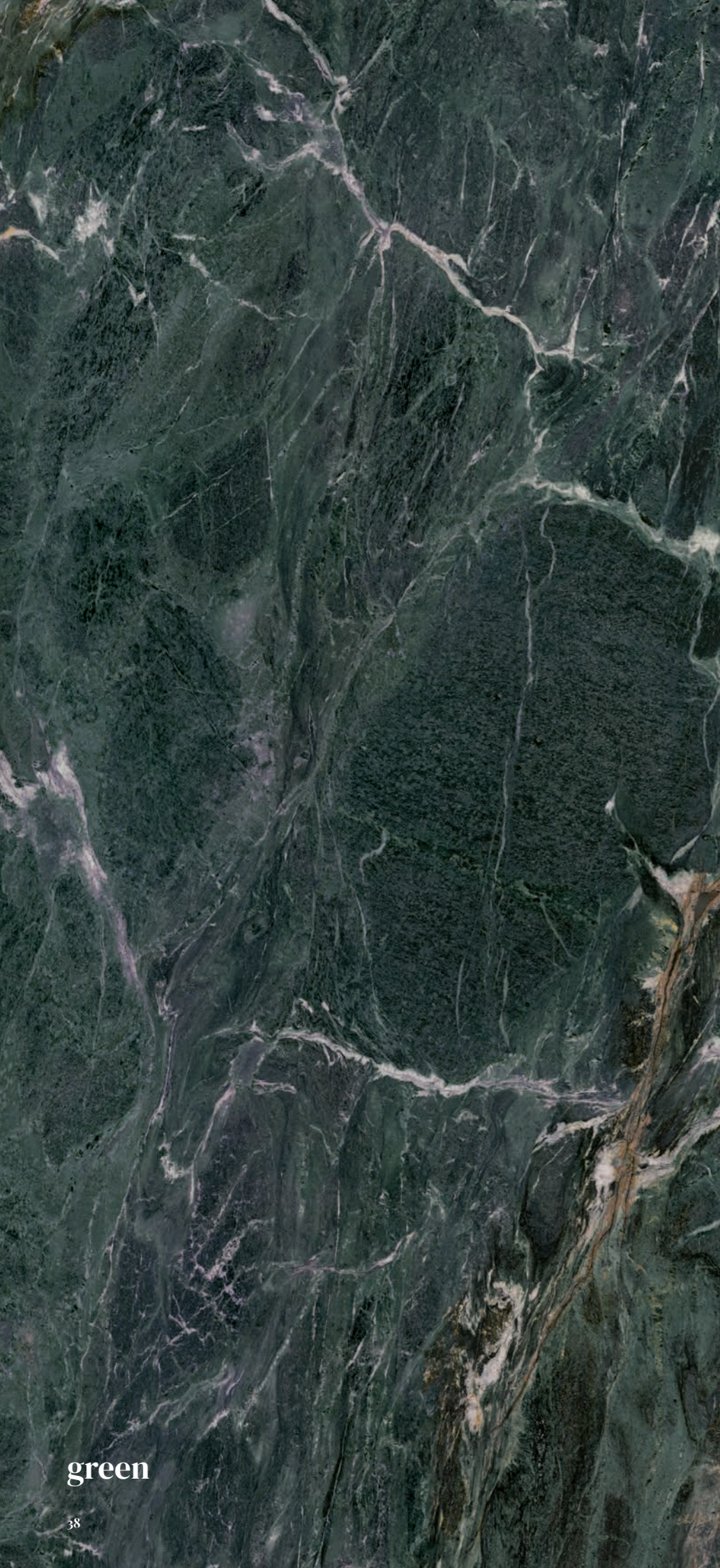

green

Formatos / Sizes / Format



Disponible / Available / Disponible:  
Cat. MATERIA

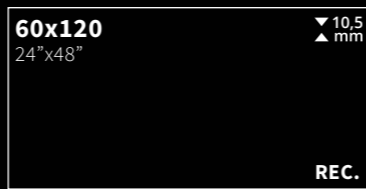

32,5x22,5  
13"x9"



30x30 (5x5)  
12"x12"



13x15  
5"x6"

# LUX EUPHORIA

CR. LUX  
GRES PORCELÁNICO RECTIFICADO-GRANILLA PULIDA  
RECTIFIED PORCELAIN TILES-POLISHED GRANILLA  
GRÈS CÉRAMÉ RECTIFIÉE - GRANILLA POLI



Rvto. / Wall / Rvtm.: Lux Euphoria Green 120x120  
Pvto. / Floor / Sol: Konzept Nacar 120x120

Empaquetado / Packaging / Emballage

Formato	pz/pl	m <sup>2</sup> /caja	m <sup>2</sup> /pl	kg/pl
120x280	20	3.36	67.20	1,130.00

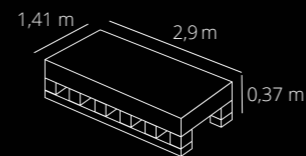

\*Medidas en centímetros  
\*Dimensions in centimeters  
\*Dimensions en centimètres

Lux Euphoria Green

● 120x280 Rec. M316 054.961.0110.12230



# LUX JATOBÁ

## COCOA BROWN

LUX JATOBÁ resume la belleza y sinuosidad de la cuarcita brasileña. Le protagonizan sus curvas en tonos suaves y la profundidad de su color marrón cacao con reminiscencias grisáceas. Detalles que convierten a esta pieza en la joya de cualquier estancia.

## COCOA BROWN

LUX JATOBÁ embodies all the beauty and sinuosity of Brazilian quartzite. Soft-coloured waves are combined with deep cocoa brown, shot with a hint of grey. All these details are guaranteed to draw all eyes wherever Jatobá is used.

## COCOA BROWN

LUX JATOBÁ résume la beauté et la sinuosité du quartzite brésilien. Il se caractérise par ses courbes dans des tons doux et la profondeur de sa couleur cacao avec des réminiscences grisâtres. Des détails qui font de cette pièce le joyau de tous les espaces.





Formatos / Sizes / Format

**120x280**  
48"x110"

6 mm

Disponible / Available / Disponible:  
Cat. MATERIA

**120x120**  
48"x48"

▼ 10,2 mm  
▲ 10,2 mm

REC.

**60x120**  
24"x48"

▼ 10,5 mm  
▲ 10,5 mm

REC.



**32,5x22,5**  
13"x9"



**30x30 (5x5)**  
12"x12"



**13x15**  
5"x6"

# LUX JATOBÁ

**CR. LUX**  
GRES PORCELÁNICO RECTIFICADO-GRANILLA PULIDA  
RECTIFIED PORCELAIN TILES-POLISHED GRANILLA  
GRÈS CÉRAMÉ RECTIFIÉE - GRANILLA POLI



Rvto. / Wall / Rvtrm.: Jatobá Brown 120x280  
Pvto. / Floor / Sol: Mosa Sable 90x90

## Empaquetado / Packaging / Emballage

Formato	pz/pl	m <sup>2</sup> /caja	m <sup>2</sup> /pl	kg/pl
120x280	20	3.36	67.20	1,130.00

## Lux Jatobá Brown

● 120x280 Rec. M316 054.961.0109.09565

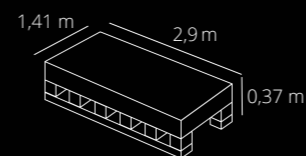

\*Medidas en centímetros  
\*Dimensions in centimeters  
\*Dimensions en centimètres

# LUX LAURANTS

## EMPODERADO Y ELEGANTE

Sobre un fondo oscuro color cacao destacan unas vetas doradas y color tierra que dan forma a LUX LAURANTS, una serie que emula el clásico mármol Saint Laurent, perfecto para crear un punto focal en los interiores más exigentes.

## EMPOWERED AND ELEGANT

Earth tone and golden veining stand out against a dark cacao background in LUX LAURANTS, a series reminiscent of the classic Saint Laurent marble, just the thing for creating a focal point in very special interiors.

## PUISSANCE ET ÉLÉGANCE

Des veinures dorées et couleur terre sont mises en valeur sur un fond sombre couleur cacao et donnent naissance à LUX LAURANTS, une série qui reproduit le marbre classique Saint Laurent, idéal pour créer un centre d'attention au sein des intérieurs les plus exigeants.







brown

Formatos / Sizes / Format



Disponibile / Available / Disponible:  
Cat. MATERIA

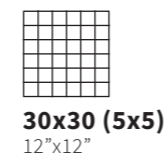
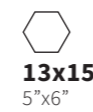
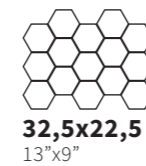
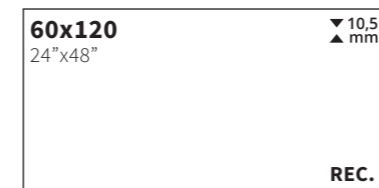
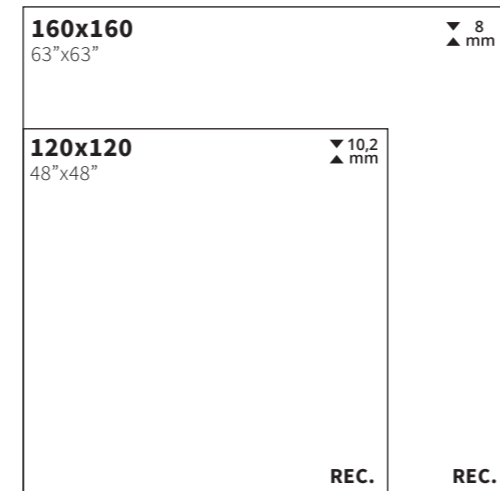

# LUX LAURANTS

CR. LUX  
GRES PORCELÁNICO RECTIFICADO-GRANILLA PULIDA  
RECTIFIED PORCELAIN TILES-POLISHED GRANILLA  
GRÈS CÉRAMÉ RECTIFIÉE - GRANILLA POLI



Rvto. / Wall / Rvrm.: Lux Laurants Brown 120x280  
Pvto. / Floor / Sol: Mosa Sable 90x90

Empaquetado / Packaging / Emballage

Formato	pz/pl	m <sup>2</sup> /caja	m <sup>2</sup> /pl	kg/pl
120x280	20	3.36	67.20	1,130.00

Lux Laurants Brown

● 120x280	Rec.	M316	054.961.0109.05151	
-----------	------	------	--------------------	--

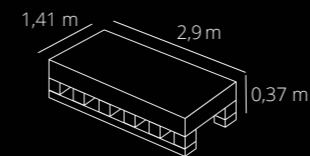

\*Medidas en centímetros  
\*Dimensions in centimeters  
\*Dimensions en centimètres

# LUX PORTORO

## FUERZA Y ELEGANCIA

Este singular modelo toma su máxima inspiración en el mármol Portoro, una exclusiva pieza extraída de las canteras italianas de Isla de Palmaria. El insondable negro cristalino de su base se ve interrumpido por un espectacular estallido de vetas doradas y destellos blancos. Lux Portoro es una joya única que convertirá cualquier espacio en el atractivo de todas las miradas.

## CHARISMATIC ELEGANCE

This highly singular model is inspired by Portoro, an exclusive marble from the Italian island of Palmaria. Its fathomless crystal-clear black background is streaked with spectacular golden veins and white sparkles. Lux Portoro is a unique jewel, able to transform any setting into an immediate focal point.

## FORCE ET ÉLÉGANCE

Ce modèle singulier puise son inspiration du marbre Portoro, une pièce extraite des carrières italiennes de l'île de Palmaria. Le noir cristallin insondable de sa base est interrompu par une explosion spectaculaire de veines dorées et d'éclats blancs. Lux Portoro est un joyau unique qui fera converger tous les regards sur l'espace qui l'arbore.





Formatos / Sizes / Format



Disponibile / Available / Disponible:  
Cat. MATERIA

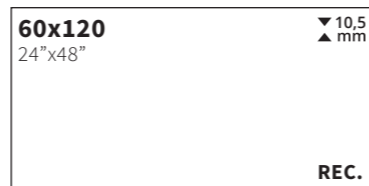
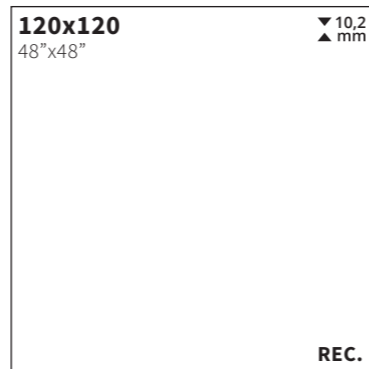

**32,5x22,5**  
13"x9"



**30x30 (5x5)**  
12"x12"

# LUX PORTORO

**CR. LUX**  
GRES PORCELÁNICO RECTIFICADO-GRANILLA PULIDA  
RECTIFIED PORCELAIN TILES-POLISHED GRANILLA  
GRÈS CÉRAMÉ RECTIFIÉE - GRANILLA POLI



Rvto. / Wall / Rvtrm.: Lux Portoro Nero 120x280  
Pvto. / Floor / Sol: Cromat Marfil 120x120

Empaquetado / Packaging / Emballage

Formato	pz/pl	m <sup>2</sup> /caja	m <sup>2</sup> /pl	kg/pl
120x280	20	3.36	67.20	1,130.00

Lux Portoro Nero

● 120x280 Rec. M316 054.961.0215.13372

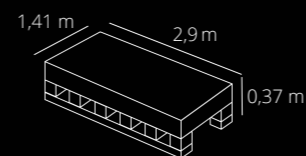

\*Medidas en centímetros  
\*Dimensions in centimeters  
\*Dimensions en centimètres

# MOLEANOS

## AIRE DE EXCLUSIVIDAD

De origen portugués. El diseño de esta piedra caliza destaca por la presencia de pequeños fósiles que quedan a la vista en forma de manchas oscuras. Una pieza perfecta para aportar serenidad y exclusividad a cualquier proyecto.

## AIR OF EXCLUSIVE

Inspired by a limestone of Portuguese origin, dotted with tiny fossils that form dark stains on the surface, **Moleanos** brings a soothing air of exclusive distinction to projects of all kinds.

## AIR D'EXCLUSIVITÉ

D'origine portugaise. Le design de cette pierre calcaire se distingue par la présence de petits fossiles, qui apparaissent sous forme de taches sombres. Une pièce parfaite pour apporter sérénité et exclusivité à tous les projets.





pearl

sand

Formatos / Sizes / Format



Disponibile / Available / Disponible:  
Cat. MATERIA

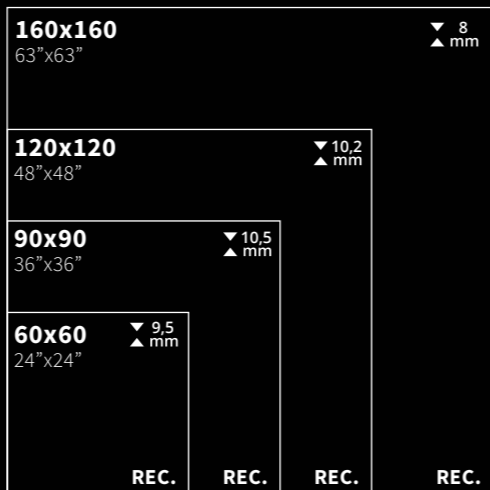
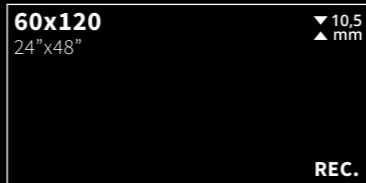

30x30 (5x5)  
12"x12"

# MOLEANOS



**DECORSTONE**  
GRES PORCELÁNICO RECTIFICADO  
RECTIFIED PORCELAIN TILES  
GRÈS CÉRAMÉ RECTIFIÉE



Rvto. / Wall / Rvrm.: Moleanos Pearl 120x280 - Cellini Blanco 120x280  
Pvto. / Floor / Sol: Moleanos Pearl 120x120

Empaquetado / Packaging / Emballage

Formato	pz/pl	m <sup>2</sup> /caja	m <sup>2</sup> /pl	kg/pl
120x280	20	3.36	67.20	1,130.00

Moleanos Pearl

● 120x280	Rec.	M220	052.961.0169.09587	
-----------	------	------	--------------------	--

Moleanos Sand

● 120x280	Rec.	M220	052.961.0119.09587	
-----------	------	------	--------------------	--

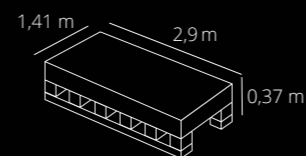

\*Medidas en centímetros  
\*Dimensions in centimeters  
\*Dimensions en centimètres

# MONTPELLIER

## BELLEZA FRANCESA

Refleja la particularidad de la piedra de Borgoña, única por las intrusiones de otros fósiles y minerales. Montpellier evoca el encanto de este material natural perfecto para vivir tanto en interiores domésticos como espacios de contract.

## FRENCH BEAUTY

It reflects the uniqueness of Bourgogne limestone, standing out for the intrusions of other fossils and minerals. Montpellier evokes the charm of this natural material, perfect for experiencing in both domestic interiors and in contract spaces.

## LA BEAUTÉ FRANÇAISE

Elle reflète la particularité de la pierre de Bourgogne, dont le caractère unique est dû aux intrusions d'autres fossiles et minéraux. Montpellier évoque le charme de ce matériau naturel, parfait pour vivre dans des intérieurs domestiques ou des espaces de collectivité.





bone

Formatos / Sizes / Format



Disponibile / Available / Disponible:  
Cat. MATERIA

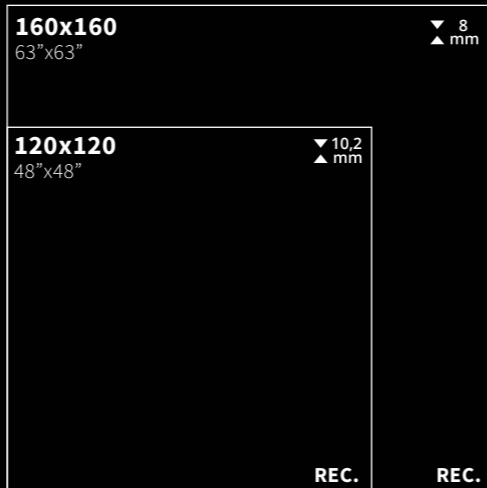
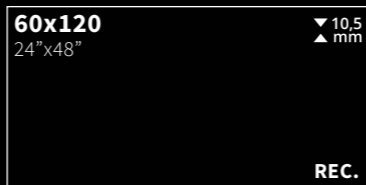

# MONTPELLIER

**DECORSTONE**  
GRES PORCELÁNICO RECTIFICADO  
RECTIFIED PORCELAIN TILES  
GRÈS CÉRAMÉ RECTIFIÉE



Rvto. / Wall / Rvtm.: Konzept Nacar 120x280  
Pvto. / Floor / Sol: Montpellier Bone 160x160

Empaquetado / Packaging / Emballage

Formato	pz/pl	m <sup>2</sup> /caja	m <sup>2</sup> /pl	kg/pl
120x280	20	3.36	67.20	1,130.00

Montpellier Bone

● 120x280 Rec. M220 052.961.0413.10503

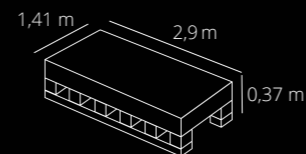

\*Medidas en centímetros  
\*Dimensions in centimeters  
\*Dimensions en centimètres

# NEBULA

## SKYLINE WHITE

Un diseño que recuerda a dunas desérticas en tonos café sobre un fondo blanco cremoso.

**NEBULA** recrea al singular mármol Skyline White, en el que destaca la singularidad de sus vetas largas y difuminadas en perpetuo movimiento.

## SKYLINE WHITE

With a design evocative of coffee-coloured desert dunes on a creamy white background, **NEBULA** recreates all the beauty of Skyline White, a highly distinctive marble with unusual long, blurred veins in an apparent state of perpetual movement.

## SKYLINE WHITE

Un design qui rappelle les dunes désertiques dans des tons café sur un fond blanc crème.

**NEBULA** recrée le singulier marbre Skyline White, où se détache la singularité de ses veines allongées et estompées dans un mouvement perpétuel.







Formatos / Sizes / Format



# NEBULA

**CR. LUX**  
GRES PORCELÁNICO RECTIFICADO-GRANILLA PULIDA  
RECTIFIED PORCELAIN TILES-POLISHED GRANILLA  
GRÈS CÉRAMÉ RECTIFIÉE - GRANILLA POLI



Disponible / Available / Disponible:  
Cat. MATERIA

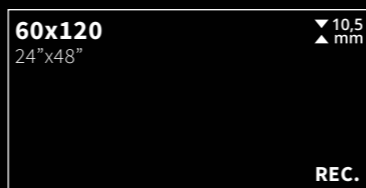

**32,5x22,5**  
13"x9"



**30x30 (5x5)**  
12"x12"



**13x15**  
5"x6"

Empaquetado / Packaging / Emballage

Formato	pz/pl	m <sup>2</sup> /caja	m <sup>2</sup> /pl	kg/pl
120x280	20	3.36	67.20	1,130.00

Nebula Almond

● 120x280 Rec. M316 054.961.0097.09877

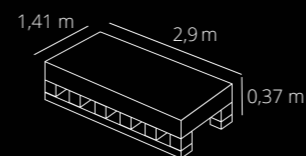

\*Medidas en centímetros  
\*Dimensions in centimeters  
\*Dimensions en centimètres

# PISA

## ESENCIA DE 'CALACATTA'

La exclusiva gráfica de sus vetas fuertes y audaces encuentran la inspiración en el clásico e índemne mármol Macchia Vecchia. PISA presenta un cromatismo peculiar, con un blanco roto y unas finas vetas grises que se ven envueltas por el encanto de sus tonalidades ámbar y doradas.

## THE ESSENCE OF 'CALACATTA' MARBLE

This series' exclusive strong-veined bold design is inspired by timeless classical Macchia Vecchia marble. PISA comes in a unique combination of colours, with an offwhite background covered in fine grey veins, charmingly streaked with amber and gold.

## ESSENCE DE 'CALACATTA'

Le design exclusif de ses veinures fortes et audacieuses puise son inspiration dans le marbre Macchia Vecchia, classique et immuable. PISA présente un chromatisme particulier, avec un blanc cassé et de fines veinures grises mises en valeur par le charme de ses tonalités ambre et dorées..



Rvto. / Wall / Rvtm.: Pisa Gold 120x280 - Koncep Argent 120x280  
Pvto. / Floor / Sol: Montpellier Graphite 120x120



Formatos / Sizes / Format



Disponible / Available / Disponible:  
Cat. MATERIA

<b>160x160</b> 63"x63"	▼ 8 ▲ mm
<b>120x120</b> 48"x48"	▼ 10,2 ▲ mm
<b>90x90</b> 36"x36"	▼ 10,5 ▲ mm
<b>60x60</b> 24"x24"	▼ 9,5 ▲ mm
REC.	REC.

<b>60x120</b> 24"x48"	▼ 10,5 ▲ mm
<b>30x60</b> 8"x48"	▼ 9,5 ▲ mm
REC.	REC.

<b>90x180</b> 36"x71"	▼ 11,5 ▲ mm
<b>75x150</b> 30"x60"	▼ 10,5 ▲ mm
<b>45x90</b> 18"x36"	▼ 10,5 ▲ mm
REC.	REC.

gold

# PISA



**CR. LUX**  
GRES PORCELÁNICO RECTIFICADO-GRANILLA PULIDA  
RECTIFIED PORCELAIN TILES-POLISHED GRANILLA  
GRÈS CÉRAMÉ RECTIFIÉE - GRANILLA POLI

**COMPACGLASS**  
GRES PORCELÁNICO ESMALTADO RECTIFICADO  
RECTIFIED GLAZED PORCELAIN TILES  
GRÈS CÉRAMÉ ÉMAILLÉ RECTIFIÉE



Rvto. / Wall / Rvtrm.: Pisa Gold 120x280  
Pvto. / Floor / Sol: Mosa Coal 90x90



**32,5x22,5**  
13"x9"



**Malla Twisted Gold 21x26**  
(Pisa Gold + Ardesia Noir)

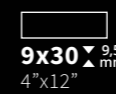

**9x30** ▼ 9,5  
4"x12" ▲ mm



**13x15**  
5"x6"

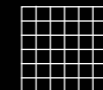

**30x30 (5x5) / (7x7)**  
12"x12"

**Pisa Gold**

● 120x280	Rec.	M316	054.961.0189.00145	
● 120x280	Rec.	M220	052.961.0189.00145	

**Empaquetado / Packaging / Emballage**

Formato	pz/pl	m <sup>2</sup> /caja	m <sup>2</sup> /pl	kg/pl
120x280	20	3.36	67.20	1,130.00

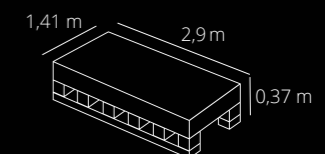

\*Medidas en centímetros  
\*Dimensions in centimeters  
\*Dimensions en centimètres

# PLAIN



**DECORSTONE**  
GRES PORCELÁNICO RECTIFICADO  
RECTIFIED PORCELAIN TILES  
GRÈS CÉRAMÉ RECTIFIÉE

Formatos / Sizes / Format



### Plain White

• 120x280 Rec. M220 052.961.0108.09879

### Plain Black

• 120x280 Rec. M220 052.961.0157.09879

### Empaquetado / Packaging / Emballage

Formato	pz/pl	m <sup>2</sup> /caja	m <sup>2</sup> /pl	kg/pl
120x280	20	3.36	67.20	1,130.00

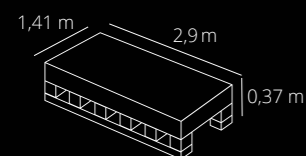

\*Medidas en centímetros  
\*Dimensions in centimeters  
\*Dimensions en centimètres

black

white



Rvto. / Wall / Rvrm.: Plain Black 120x280 - Plain White 120x280  
Pvto. / Floor / Sol: Mosa Gris 90x90



# TORANO

## INFUSIÓN ACARAMELADA

La gran variedad estética del eterno Paonazzo está reflejada en **TORANO**. Un diseño altamente diferencial y de gran belleza, caracterizado por su alto valor decorativo. Este mármol, muestra en sus finas vetas, una infusión acaramelada, pero con matices oscuros. En su esencia se aprecia el efecto del mármol oxidado a causa del paso del tiempo.

## CARAMEL WITH DARKER HINTS OF COLOUR

**TORANO** reflects the visual diversity of Paonazzo marble. With its timeless beauty and singular design, strong decorative appeal is guaranteed. The slender veins of this marble combine shades of caramel with darker hints of colour, in addition to signs of oxidation slowly built up over time.

## TON CARAMEL, MAIS AVEC DES NUANCES SOMBRES

La grande variété esthétique de l'éternel Paonazzo se reflète dans **TORANO**. Un design hautement différentiel et d'une grande beauté, caractérisé par sa haute valeur décorative. Ce marbre présente dans ses veines fines un ton caramel, mais avec des nuances sombres. En son essence on observe l'effet du marbre oxydé par le passage du temps





**dorado**

Formatos / Sizes / Format



Disponibile / Available / Disponible:  
Cat. MATERIA

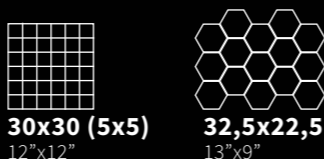
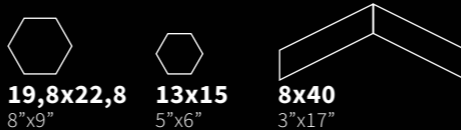
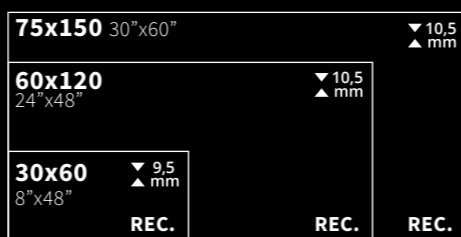
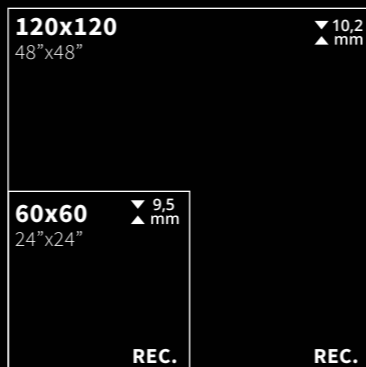

**\*7,5x30**  
3"x12"  
\*RVTO. PASTA BLANCA  
\*WHITE BODY WALL TILES  
\*REVÊTEMENT PÂTE BLANCHE

# TORANO



**CR. LUX**  
GRES PORCELÁNICO RECTIFICADO-GRANILLA PULIDA  
RECTIFIED PORCELAIN TILES-POLISHED GRANILLA  
GRÈS CÉRAMÉ RECTIFIÉE - GRANILLA POLI

**COMPACGLASS**  
GRES PORCELÁNICO ESMALTADO RECTIFICADO  
RECTIFIED GLAZED PORCELAIN TILES  
GRÈS CÉRAMÉ ÉMAILLÉ RECTIFIÉE



Rvto. / Wall / Rvrm.: Golden Leopard Black Oro Brillo 60x120 - Torano Dorado 60x120  
Pvto. / Floor / Sol: Torano Dorado 120x120

Empaquetado / Packaging / Emballage

Formato	pz/pl	m <sup>2</sup> /caja	m <sup>2</sup> /pl	kg/pl
120x280	20	3.36	67.20	1,130.00

**Torano Dorado**

● 120x280	Rec.	M316	054.961.0103.09878	
● 120x280	Rec.	M220	052.961.0103.09878	

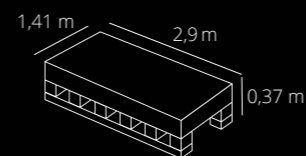

\*Medidas en centímetros  
\*Dimensions in centimeters  
\*Dimensions en centimètres

*Get inspired...*



Armonia 



Nebula Almond 



Desert Natural 



Moleanos Sand 



Moleanos Pearl 

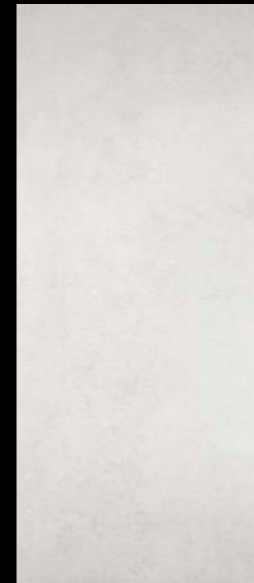

Koncept Nacar 



Koncept Argent 



Montpellier Bone 



Torano Dorado 



Lux Laurants Brown 



Lux Deva Nero 

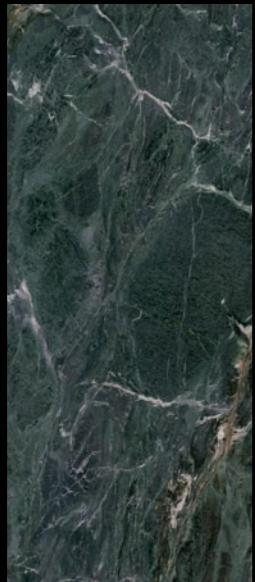

Lux Euphoria Green 



Lux Portoro 

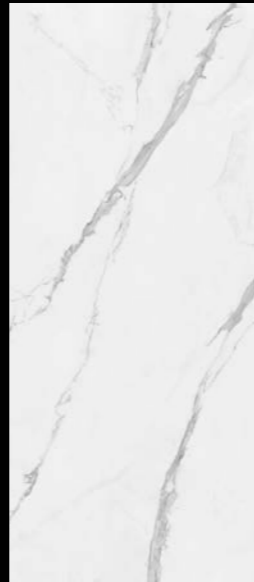

Cellini Blanco 

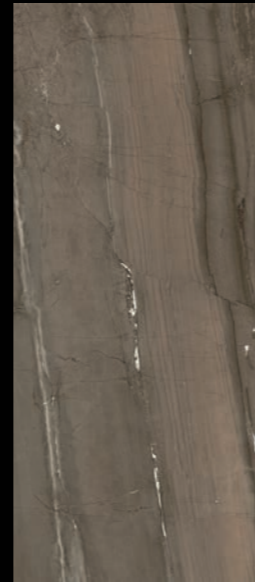

Lux Jatoba Brown 



Etro Blanco 



Etro Marfil 



Crystal White 

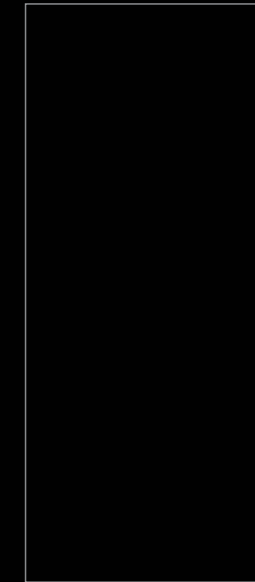

Plain Black 



Plain White 



Eleganza Perla 



Eleganza Grigio 



Eleganza Blu 



Eleganza Beige 



Eleganza Siena 



Eleganza Terra 



Eleganza Saggio 



Pisa Gold 

## EXPOSITOR PARA FORMATO 120x280

DISPLAY UNIT FOR 120x280 FORMAT / PRÉSENTOIR POUR FORMAT 120x280

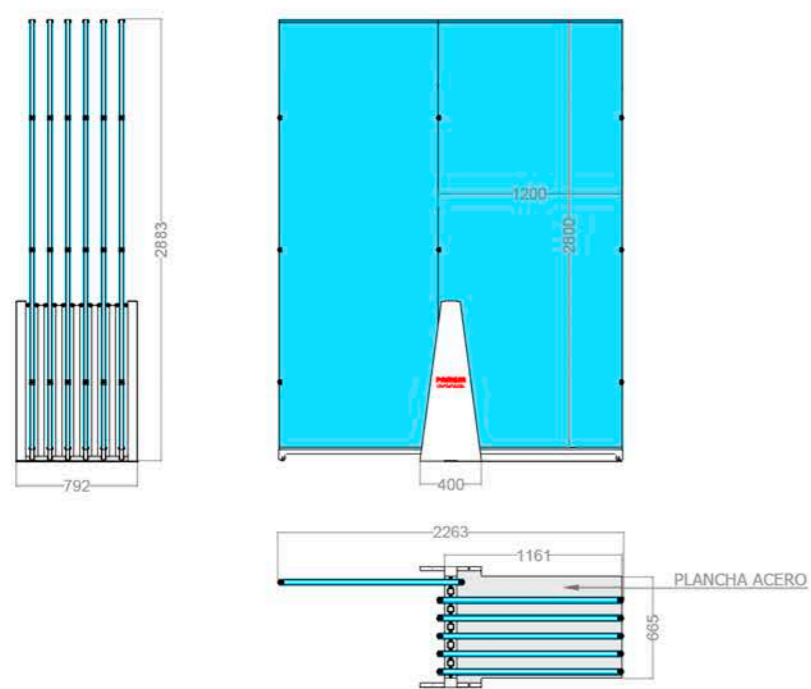

6 CARRILES  
RAILS / RAILS

## CAJA XXL

XXL BOX / BOÎTE XXL

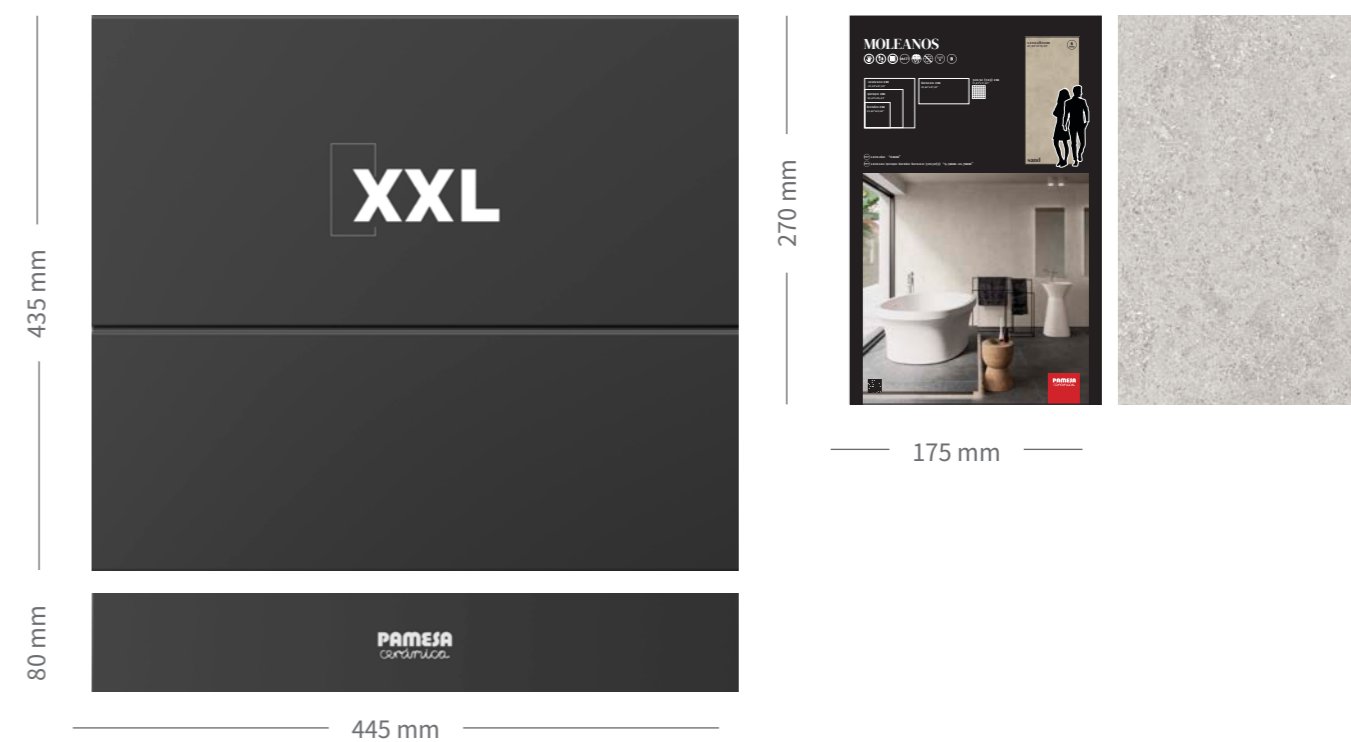

Dimensiones y acabados pueden sufrir pequeñas variaciones por cuestiones técnicas.  
Due to technical reasons, dimensions and finishes may vary slightly.  
Pour des raisons techniques, les dimensions et finitions peuvent varier très légèrement.

Dimensiones y acabados pueden sufrir pequeñas variaciones por cuestiones técnicas.  
Due to technical reasons, dimensions and finishes may vary slightly.  
Pour des raisons techniques, les dimensions et finitions peuvent varier très légèrement.



## TRANSPORTE

### MOVING SLABS / TRANSPORT

El transporte de piezas de gran formato exige varios operarios.

Será necesario el uso de ventosas y se podrán usar en todas sus variantes (1).

Para piezas con superficie texturizada se recomienda el uso de ventosas que dispongan de una goma blanda, que garantice la adherencia de las mismas (2).

Para facilitar el manejo y evitar la deformación, se pueden usar barras de transporte (3).

La solución óptima, consiste en el uso de un bastidor rígido, dotado de ventosas, que sujete las piezas en todas direcciones sin deformaciones, posibilitando el transporte con solo dos operarios.

Several workmen will be needed to carry large-format slabs.

Suctions cups will be necessary. Different types can be used (1).

In the case of slabs with a textured surface, soft-rubber suction cups should be used to guarantee a good grip (2).

To handle the slabs more easily and prevent the risk of warpage, carrying bars should be used (3).

The best solution is a rigid frame, with suction cups that grip the slab along all sides. This prevents warpage and allows just two workmen to carry it.

Le transport des pièces de grand format requiert plusieurs opérateurs.

Il sera nécessaire d'employer des ventouses et on pourra les utiliser dans toutes leurs variantes (1).

Pour les pièces avec une surface texturisée, il est recommandé l'utilisation de ventouses qui ont un caoutchouc mou pouvant garantir leur adhérence (2).

Pour faciliter le maniement et éviter les déformations, on peut utiliser des barrestransport (3).

La meilleure solution est d'utiliser un support rigide muni de ventouses pour fixer les pièces dans toutes les directions sans déformations, ce qui permet que deux opérateurs suffisent pour réaliser le transport.

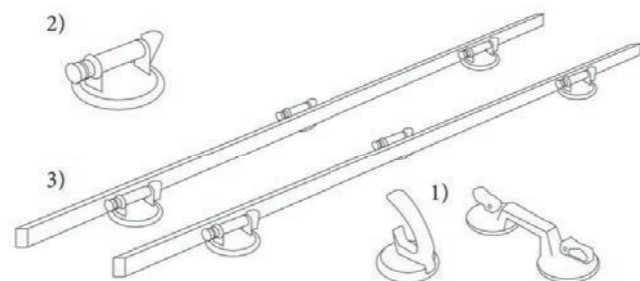

## RECOMENDACIONES DE ALMACENAMIENTO

### STORAGE RECOMMENDATIONS / RECOMMANDATIONS DE STOCKAGE

Para una correcta manipulación de los cajones, se usará una carretilla elevadora con palas de 2,5 metros de longitud extendidas al máximo.

En condiciones normales, situar las palas en la mitad de la parte más larga del pallet para sujetar la máxima profundidad.

Nunca utilizar el hueco central para cargar.

To handle the crates properly, a fork-lift truck with 2.5-metre-long forks, when fully extended, should be used.

Under normal conditions, the forks should be slid under the middle of the longest side of the pallet so that they support most of the underside.

Never use the central opening in the crates to load them.

Pour une manipulation adéquate des caisses, on utilisera un chariot élévateur de 2,5 m de longueur à son extension maximale.

Dans des conditions normales, les fourches se placent au centre de la partie longue de la palette pour les introduire au plus profond de la palette.

Ne jamais introduire de fourche dans le creux central pour charger.

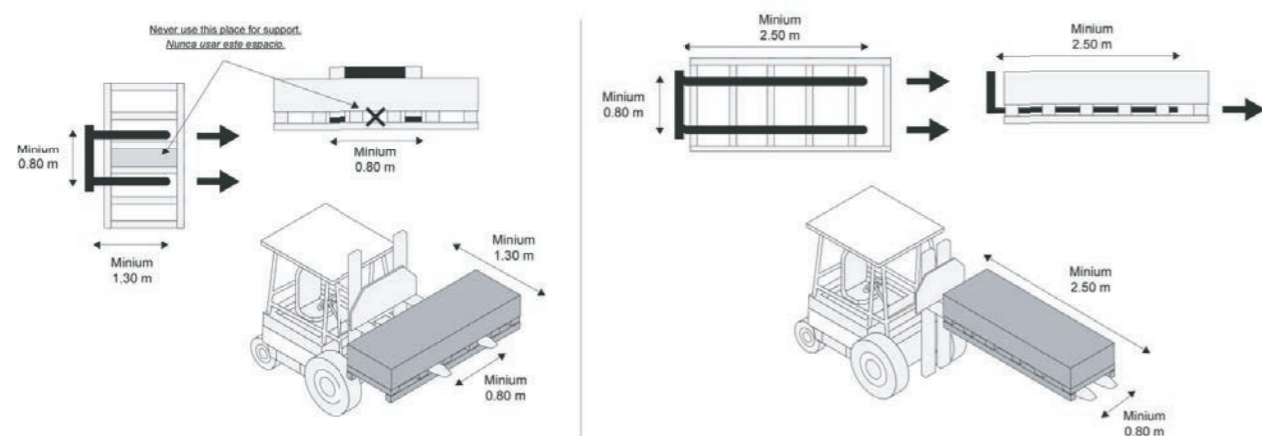

## RECOMENDACIONES DE CORTE, PERFORACIÓN Y ACABADO

### CUTTING, DRILLING AND FINISHING RECOMMENDATIONS / RECOMMANDATIONS DE COUPE, PERÇAGE ET FINITION

Las grandes dimensiones de las piezas no impiden operaciones de corte, perforación y acabados de cantos y se pueden realizar en la misma obra con el equipamiento adecuado.

#### CORTE CON GUÍAS DE CORTE EN SECO

01. Primero se coloca la pieza cerámica en la mesa de trabajo.

02. Se marca la línea de corte, situamos la guía y la fijamos en su posición.

03. A continuación, se raya con el rodel la pieza, marcando los dos primeros centímetros hacia atrás y continuando con el resto de la placa, marcando con fuerza constante hasta el extremo contrario.

04. Para proceder con la separación, se presiona con la tenaza hasta escuchar el sonido de la rotura.

05. Finalmente se separan las piezas restantes con ayuda del borde de la mesa y ejerciendo la fuerza necesaria.

Despite the large dimensions of the tiles, they can be cut, drilled and their edges finished. This can be done on the worksite with appropriate equipment.

#### DRY-CUTTING USING A GUIDE RAIL

01. First, place the ceramic slab on top of the workbench.

02. Mark the cutting line, and then fix the guide rail into place.

03. Score the beginning of the slab with the cutting wheel, starting two centimetres from the edge and pulling back to the beginning of the slab. Then continue across to the other side, applying constant pressure.

04. To separate the two parts, exert pressure with a pair of pliers until a breaking sound is heard.

05. Use the edge of the workbench to snap the two pieces apart, exerting the necessary pressure.

Les grandes dimensions des pièces n'empêchent pas les opérations de coupe et de perçage et les finitions des chants, et on peut les réaliser sur le propre chantier avec l'équipement adéquat.

#### DÉCOUPE AVEC GUIDES DE COUPE À SEC

01. Placer d'abord la pièce en céramique sur la table de travail.

02. Marquer la ligne de coupe, situer le guide et le fixer dans sa position.

03. Ensuite, rayer la pièce à l'aide de la molette, en marquant les deux premiers centimètres vers l'arrière puis en continuant sur le reste de la pièce, en marquant avec une force constante jusqu'à l'extrémité opposée.

04. Pour procéder à la séparation, faire pression avec la pince jusqu'à entendre un bruit de cassure.

05. Finalement, séparer les pièces restantes en s'aidant du bord de la table et en exerçant la force nécessaire.

#### CORTE CON GUÍAS Y RADIAL

También podemos hacer uso de una guía y una radial con agua.

#### CUTTING WITH A GUIDE RAIL AND RADIAL TILE SAW

También podemos hacer uso de una guía y una radial con agua.

#### DÉCOUPE AVEC GUIDES ET DISQUEUSE

On peut également utiliser un guide et une disqueuse à eau.

#### TALADROS Y AGUJEROS

Para realizar agujeros se deben usar taladros no percutores. Se recomienda empujar con bajas revoluciones y refrigerar con agua.

#### DRILLING AND MAKING HOLES

To make holes, do not use drills in the hammer mode. Start at a low speed and refrigerate the bit with water.

#### PERCEUSES ET TROUS

Pour percer des trous on doit utiliser des perceuses sans percussion. Il est recommandé de commencer avec de faibles révolutions et refroidir à l'eau.



VÍDEO DE COLOCACIÓN.  
LAYING VIDEO.  
VIDÉO DE POSE.



VÍDEO DE CORTE.  
CUTTING VIDEO.  
VIDÉO DE COUPE.

PAMESA CERÁMICA COMPACTTO, S.L.U. aplica una política de continuo desarrollo de sus productos y se reserva el derecho a realizar cambios en los productos, colores, especificaciones técnicas, packings y códigos sin previo aviso.

PAMESA ha realizado un esfuerzo considerable para que toda la información sea adecuada en el momento de la publicación del catálogo.

A causa de las limitaciones del proceso de impresión los colores reproducidos pueden sufrir ligeras variaciones con respecto al producto original.

PAMESA informa que este catálogo tiene validez a nivel informativo y por tanto no se hace responsable de los posibles errores de impresión; reservándose el derecho de realizar modificaciones sin necesidad de preaviso.

PAMESA CERÁMICA COMPACTTO, S.L.U. operates a policy of continuous development and reserves the right to make changes to its products, colours, engineering specifications, packaging and codes without prior notice.

PAMESA has taken every effort to ensure that the information contained in the catalogue is correct at the time of publication. Due to the limitations of the printing process, the colours reproduced may vary slightly from the original product.

PAMESA advises that this catalogue is only valid for information purposes and therefore does not accept responsibility for any possible printing errors.

PAMESA CERÁMICA COMPACTTO, S.L.U. applique une politique de développement continu de ses produits et se réserve le droit de réaliser des changements, que ce soit de produits, couleurs, spécifications techniques, paquetages et codifications et cela sans en aviser préalablement l'acheteur.

PAMESA a réalisé un effort considérable pour que toute l'information donnée soit adéquate au moment de la publication du catalogue. Dues aux limitations du processus d'impression, les couleurs reproduites peuvent souffrir de légères variations avec le produit original.

PAMESA vous informe que les informations de ce catalogue sont données à titre informatif et qu'elle n'est pas responsable des possibles erreurs d'impression. De plus, elle se réserve le droit de modifier les informations sans préavis.

**PAMESA**  
*cerámica*

PAMESA CERÁMICA COMPACTTO, S.L.U.

Calle Pina de Montalgrao, 2

(Carretera Vila-real - Onda Km 2,7)

12540 Vila-real, Castellón

Tel: + 34 964 50 75 00

comercial@pamesa.com

[www.pamesa.com](http://www.pamesa.com)





**PAMESA**  
*cerámica*